

Article number: 03467035
 Description: Fluro Rod end EA 35D-2RS
 Note: 35

Measures

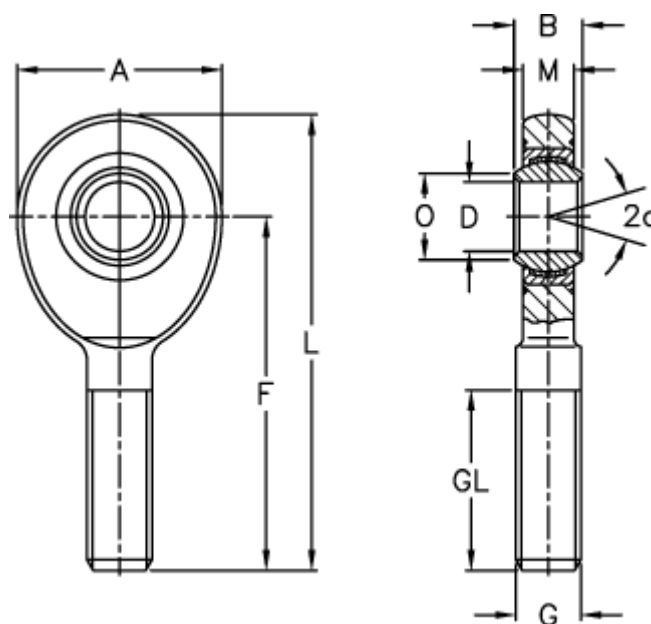

A	= 82	L	= 181
a (degrees)	= 6	M	= 21
B	= 25	O	= 39.8
D	= 35	Static drive kN	= 144
Dynamic drive (kN)	= 140	Weight	= 1400
F	= 140		
g	= M 36x3		
GL	= 82		